

# GETTING STARTED? EASY.

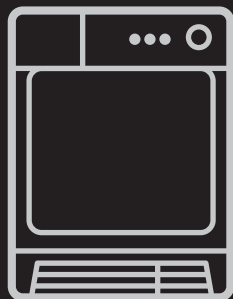

---

EN User Manual  
Tumble Dryer

FDP7406PZ

**FAURE**  

---

## VISIT OUR WEBSITE TO:

---



Get usage advice, brochures, trouble shooter, service and repair information:  
[www.faure.com/support](http://www.faure.com/support)

## SAFETY INFORMATION

---



Before beginning the installation and use of this appliance, carefully read the supplied instructions.

The manufacturer is not responsible for any injuries or damage that are the result of incorrect installation or usage. Always keep the instructions in a safe and accessible location for future reference.

## CHILDREN AND VULNERABLE PEOPLE SAFETY



### WARNING!

Risk of suffocation, injury or permanent disability.

- This appliance can be used by children aged from 8 years and above and persons with reduced physical, sensory or mental capabilities or lack of experience and knowledge if they have been given supervision or instruction concerning the use of the appliance in a safe way and understand the hazards involved.
- Children between 3 and 8 years of age and persons with very extensive and complex disabilities shall be kept away from the appliance unless continuously supervised.
- Children of less than 3 years of age should be kept away from the appliance unless continuously supervised.
- Do not let children play with the appliance.
- Keep all packaging away from children and dispose of it appropriately.
- Keep detergents away from children.
- Keep children and pets away from the appliance when the door is open.
- If the appliance has a child safety device, it should be activated.
- Children shall not carry out cleaning and user maintenance of the appliance without supervision.

## GENERAL SAFETY

- This appliance is for drying domestic-type, machine-dryable laundry only.
- Do not use the dryer function if laundry has been soiled with industrial chemicals.
- This appliance is designed for single household domestic use in an indoor environment.
- This appliance may be used in, offices, hotel guest rooms, bed & breakfast guest rooms, farm guest houses and other similar accommodation where such use does not exceed (average) domestic usage levels.
- Do not change the specification of this appliance.
- If the tumble dryer is put on top of a washing machine, use the stacking kit. The stacking kit, available from your authorized vendor, can be used only with the appliance specified in the instructions supplied with the accessory. Read it carefully before installation (refer to the Installation leaflet).
- The appliance can be installed as freestanding or below a kitchen counter with correct space (refer to the Installation leaflet).
- Do not install the appliance behind a lockable door, a sliding door or a door with a hinge on the opposite side, that would prevent the appliance door from being fully open.
- The ventilation opening in the base must not be covered by a carpet, mat, or any floor covering.
- **WARNING:** The appliance must not be supplied through an external switching device, such as a timer, or connected to a circuit that is regularly switched on and off by a utility.
- Connect the mains plug to the mains socket only at the end of the installation process. Make sure that the mains plug is accessible after installation.
- If the mains power supply cable is damaged, it must be replaced by the manufacturer, its Authorised Service Centre or similarly qualified persons to avoid an electrical hazard.
- Do not exceed the maximum load of 7 kg (refer to the "Programme chart" chapter).

- Wipe away lint or packaging debris that has accumulated around the appliance.
- Do not run the appliance without a filter. Clean the lint filter before or after each use.
- Do not dry unwashed items in the tumble dryer.
- Items that have been soiled with substances such as cooking oil, acetone, alcohol, petrol, kerosene, spot removers, turpentine, waxes and wax removers should be washed in hot water with an extra amount of detergent before being dried in the tumble dryer.
- Items such as foam rubber (latex foam), shower caps, waterproof textiles, rubber backed articles and clothes or pillows fitted with foam rubber pads should not be dried in the tumble dryer.
- Fabric softeners, or similar products, should only be used as specified by the product manufacturer's instructions.
- Remove all objects from items that could be a source of fire ignition such as lighters or matches.
- **WARNING:** Never stop a tumble dryer before the end of the drying cycle unless all items are quickly removed and spread out so that the heat is dissipated.
- Before any maintenance operation, deactivate the appliance and disconnect the mains plug from the socket.

## SAFETY INSTRUCTIONS

---

### INSTALLATION

- Remove all the packaging.
- Do not install or use a damaged appliance.
- Follow the installation instructions supplied with the appliance.
- Always take care when moving the appliance as it is heavy. Always use safety gloves and enclosed footwear.
- Do not install or use the appliance where the temperature can be lower than 5°C or higher than 35°C.
- The floor area on which the appliance is to be installed must be flat, stable, heat resistant and clean.
- Make sure that there is air circulation between the appliance and the floor.
- Always keep the appliance vertical when it is being moved.

- The rear surface of the appliance must be put against a wall.
- When the appliance is in its permanent position, check if it is levelled correctly with the aid of a spirit level. If it is not, adjust the feet accordingly.

### ELECTRICAL CONNECTION



**WARNING!** Risk of fire and electric shock.

- **WARNING:** This appliance is designed to be installed / connected to a grounding connection in the building.
- Make sure that the parameters on the rating plate are compatible with the electrical ratings of the mains power supply.

- Always use a correctly installed shockproof socket.
- Do not use multi-plug adapters and extension cables.
- Do not pull the mains cable to disconnect the appliance. Always pull the mains plug.
- Do not touch the mains cable or the mains plug with wet hands.

## USE



**WARNING!** Risk of injury, electric shock, fire, burns or damage to the appliance.

- This appliance is for household (indoors) use only.
- Do not dry damaged (torn, frayed) items that contain padding or fillings.
- If laundry has been washed with a stain remover, carry out an additional rinse cycle before starting a drying cycle.
- Dry only fabrics that are suitable to dry in the appliance. Follow the cleaning instruction on the item label.
- Do not drink or prepare food with the condensed water/distilled water. It can cause health problems to people and pets.
- Do not sit or stand on the open door of the appliance.
- Do not dry dripping wet clothes in the appliance.

## CARE AND CLEANING



**WARNING!** Risk of injury or damage to the appliance.

- Do not use water spray and steam to clean the appliance.
- Clean the appliance with a moist soft cloth. Use only neutral detergents. Do not use abrasive products, abrasive cleaning pads, solvents or metal objects.

## SERVICE

- To repair the appliance contact the Authorised Service Centre.
- Use original spare parts only.
- Concerning the lamp(s) inside this product and spare part lamps sold separately: These lamps are intended to withstand extreme physical conditions in household appliances, such as temperature, vibration, humidity, or are intended to signal information about the operational status of the appliance. They are not intended to be used in other applications and are not suitable for household room illumination.

## DISPOSAL



**WARNING!** Risk of injury or suffocation.

- Disconnect the appliance from the mains electrical and water supplies.
- Cut off the mains electrical cable close to the appliance and dispose of it.
- Remove the door catch to prevent children or pets from becoming trapped in the drum.
- Dispose of the appliance in accordance with local requirements for the disposal of Waste Electrical and Electronic Equipment (WEEE).

# EASY START

## PRODUCT DESCRIPTION

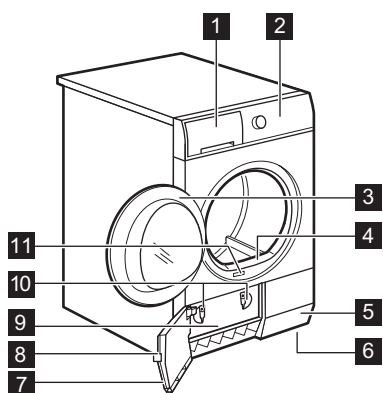

- 1** Water container
- 2** Control panel
- 3** Appliance door
- 4** Primary Filter
- 5** Airflow slots
- 6** Adjustable feet
- 7** Condenser door
- 8** Button for condenser door
- 9** Condenser cover
- 10** Locks for condenser lid
- 11** Rating plate



For ease of loading laundry or ease of installation the door is reversible. (see separate leaflet).

## CONTROL PANEL

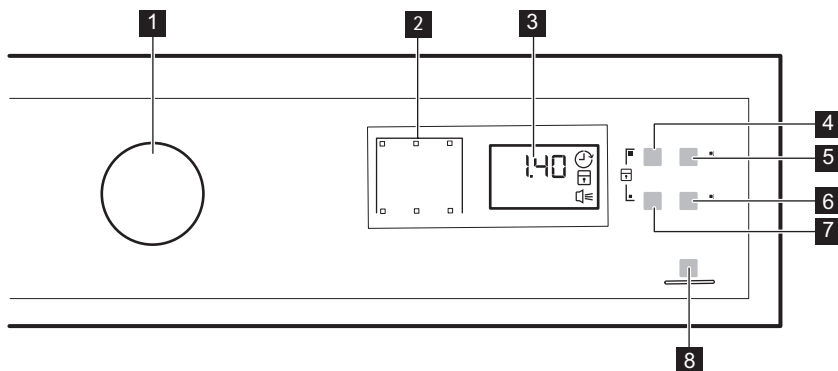

- 1** Programme knob and ⏻ OFF switch
- 2** Indicators
- 3** Display
- 4** ⌚ Minuterie touchpad
- 5** ⌚ Départ Différé touchpad
- 6** 🌸 Délicat touchpad
- 7** 🧺 Anti-froissage touchpad
- 8** ▶|| Marche/Arrêt touchpad



Press the touch buttons with your finger in the area with the symbol or name of the option. Do not wear gloves when you operate the control panel. Make sure that the control panel is always clean and dry.

## Indicators

Indicators	Description
	Drying phase
	Cooling phase
	Crease guard phase
	Condenser
	Water container
	Filter
	Delay start
	Child lock
	Acoustic signals
2.00	Programme duration
10' - 2.00	Time Drying duration
30' - 20h	Delay start duration

## PROGRAMME TABLE

Programme	Load <sup>1)</sup>	Properties / Fabric type <sup>2)</sup>	
<sup>3)</sup> Coton <b>Eco</b>	<b>7 kg</b>	Cotton fabrics programme designed for maximum energy saving.	/
Coton Très sec	<b>7 kg</b>	Drying level: extra dry.	/
Coton Prêt à ranger	<b>7 kg</b>	White and coloured cotton fabrics programme. Default setting is for ready to store dryness level.	/

Programme	Load <sup>1)</sup>	Properties / Fabric type <sup>2)</sup>	
Coton Prêt à repasser	<b>7 kg</b>	Drying level: suitable for ironing.	/
Synthétiques Très sec	<b>3,5 kg</b>	Drying level: extra dry.	/
Synthétiques Prêt à ranger	<b>3,5 kg</b>	Drying level: cupboard dry.	/
Déliçats	<b>4 kg</b>	Recommended for generic delicate fabrics such as viscose, rayon, acrylic and their blends.	/
Minuterie	<b>5 kg</b>	With this programme you can use the Minuterie option and set the programme duration. Drying time should be adequate to the load, e.g. 2h for 5 kg of cotton.	/
Rafraîchir	<b>1 kg</b>	Short low temperature cycle that helps in removing odours from a small amount of garments. Indicated also for dry clothes that were in storage for long time.	
Repassage Facile	<b>1 kg (or 5 shirts)</b>	Limits creases on small loads of cotton, synthetic and mixed-fabric garments for easy ironing. Features two drying levels: Iron leaves garments slightly damp for ironing or hanging; Cupboard fully dries items.	/
SportWear	<b>2 kg</b>	Sportswear, thin and light fabrics, microfiber, polyester, which are not ironed	/
Jeans	<b>7 kg</b>	Deeply dries jeans and other denim garments, even in thick parts like pockets, seams, and cuffs reducing entanglement.	/
Draps	<b>3kg</b>	Bed linen such as single and double sheets, pillowcases, duvet cover.	/
Mixtes	<b>3kg</b>	Cotton and synthetic fabrics. Low temperature programme. Delicate programme with warm air.	/

1) The maximum weight refers to dry items.

2) For fabric mark meaning see chapter *HINTS AND TIPS: Preparing the laundry*.

3) The Coton Prêt à ranger ECO programme is the "Standard cotton programme" according to Commission Regulation EU No. 392/2012. It is suitable for drying normal wet cotton laundry and it is the most efficient programme in terms of energy consumption for drying wet cotton laundry.



# OPTIONS

## MINUTERIE

This option is applicable only to the Minuterie programme. You can set the programme duration, from a minimum of 10 minutes to a maximum of 2 hours. The setting of the duration is related to the quantity of laundry in the appliance.



We recommend that you set a short duration for small quantities of laundry or for only one item.

drying phase, the drum rotates from time to time which prevents the clothes from creasing. Laundry can be removed during the anti-crease phase.





## DÉLICAT

With this option you can set a delicate drying programme that has a low temperature. Use this option with a fabrics that have the symbol  on the fabric label (e.g. acrylic, viscose).

## ANTI-FROISSAGE

Extends up to 90 minutes the anticrease phase (30 minutes) at the end of the drying cycle. After the

### OPTIONS TABLE

Programmes <sup>1)</sup>	 Anti-froissage	 Minuterie	 Délicat
 Coton <b>Eco</b>	■		
Coton Très sec	■		■
Coton Prêt à ranger	■		■
Coton Prêt à repasser	■		■
Synthétiques Très sec	■		■
Synthétiques Prêt à ranger	■		■
Délicats	■		■
Minuterie	■	■	■
Rafraîchir	■		
Repassage Facile	■		■
SportWear	■		
Jeans	■		■
Draps	■		
Mixtes	■		

1) Together with the programme you can set 1 or more options. To activate or deactivate them, press the related touch button.

# SETTINGS

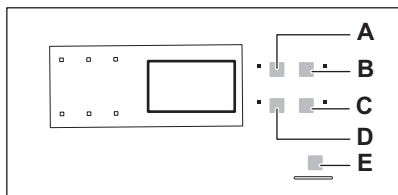

- A. Minuterie touchpad
- B. Départ Différé touchpad
- C. Délicat touchpad
- D. Anti-froissage touchpad
- E. Marche/Arrêt touchpad

## CHILD LOCK FUNCTION

This option prevents children to play with the appliance while a programme operates. The programme knob and the touchpads are locked.

Only OFF switch is unlocked.

### Activating the child lock option:

1. Use the programme knob to set any programme.
2. Wait approximately 8 seconds.
3. Press and hold touchpads (A) and (D) at the same time. The child lock indicator comes on.

The child lock indicator comes on.

## BEFORE FIRST USE

Rear drum locks are removed automatically when dryer is activated for the first time. Possible to hear some noise.

### To unlock the rear drum locks:

1. Switch on the appliance.
2. Set any programme.
3. Press the Start/Pause button.

Drum starts to rotate. Rear drum locks are automatically deactivated.

### Before you use the appliance to dry items:

- Clean the tumble dryer drum with a moist cloth.
- Start a 1 hour programme with moist laundry.

## UNUSUAL SMELL

The appliance is tightly packed.

It is possible to deactivate the child lock option while a programme operates. Press and hold the same touchpads until the child lock indicator goes off.

## ADJUSTMENT OF DEFAULT DRYNESS LEVEL

To change the default dryness level:

1. Use the programme knob to set any programme.
2. Wait approximately 8 seconds.
3. Press and hold buttons (A) and (B) at the same time.

One of the these indicators comes on:

- the maximum dry laundry
- the more dry laundry
- the standard dry laundry

4. Press the button (E) again and again until the indicator of the correct level comes on.
5. To confirm the adjustment, press and hold buttons (A) and (B) at the same time for approximately 2 seconds.

## BUZZER ON/OFF

To deactivate or activate the acoustic signals, press and hold for approximately 2 seconds touch buttons (B) and (C) at the same time.

After product unpacking you can feel an unusual smell. This is normal for brand new products.

Appliance is built of several different types of material which all together can generate unusual smell.

Over usage time, after few drying cycles unusual smell gradually disappears.

## NOISES

Different noises may be heard at different times during the drying cycle. They are perfectly normal operating sounds.

### Rotating drum.

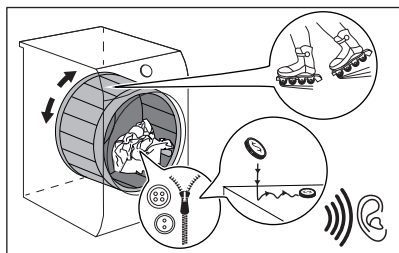

**Working fans.**

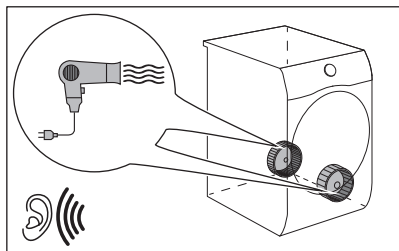

**Working pump and transferring condensation to the tank.**

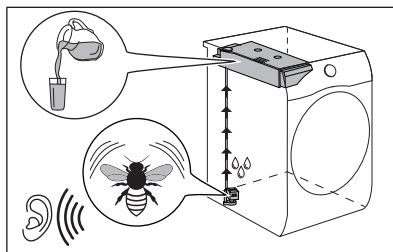

## DAILY USE

### START A PROGRAMME WITHOUT DELAY START

1. Prepare the laundry and load the appliance.

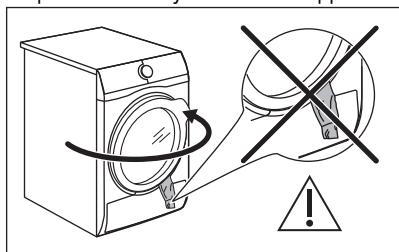

**CAUTION!** Make sure that when you close the door, the laundry does not get caught between the appliance door and the rubber seal.

2. Set the correct programme and options for the type of load.

The display shows the programme duration.



Real drying time will depend on type of the load (quantity and composition), the room temperature and the humidity of your laundry after spin drying phase.

3. Press the Marche/Arrêt touch button.

The programme starts.

### STARTING THE PROGRAMME WITH DELAY START

1. Set the correct programme and options for the type of load.
2. Press the delay start button again and again until the display shows the delay time you want to set.



You can delay the start of a programme from a minimum of 30 minutes to a maximum of 20 hours.

3. Press the Marche/Arrêt touchpad.

### The display shows the countdown of the delay start.



When the countdown is completed, the programme starts.

### CHANGE A PROGRAMME

1. Turn the Programme knob to ⓪ OFF
2. Set the programme.

### AT THE END OF THE PROGRAMME



When the programme is completed:

- An intermittent acoustic signal operates.
- The indicator  flashes.
- The indicator  flashes.
- The Marche/Arrêt indicator is on.

The appliance continues to operate with the crease guard phase for approximately other 30 minutes. The crease guard phase prevents creases from your laundry.

You can remove the laundry before the crease guard phase is completed. We recommend, for better results, that you remove the laundry when the phase is almost completed.

When the crease guard phase is completed:

- The indicator  is on but does not flash.
- The indicator  is on but does not flash.
- Marche/Arrêt indicator goes off.

1. Turn the Programme knob to  OFF
2. Open the appliance door.
3. Remove the laundry.

## HINTS AND TIPS

### PREPARING THE LAUNDRY



Very often the clothes after washing cycle are kneaded and tangled altogether.

Drying kneaded and tangled clothes is inefficient.

To assure proper air flow and even drying it is recommended to shake and load one by one the clothes to the tumble dryer.

To assure proper drying process:

- Close the zips.
- Close the fasteners of duvet covers.
- Do not dry ties or ribbons loose (e.g. apron ribbons). Tie them before you start a programme.
- Remove all items from pockets.

4. Close the appliance door.

Possible causes of unsatisfactory drying results:

- Inadequate default dryness level settings. See chapter *Adjustment of default dryness level*







**Always clean the filter and empty the water container when a programme is completed.**

### STAND-BY FUNCTION

To decrease the energy consumption, this function automatically deactivates the appliance:

- After 5 minutes if you do not start the programme.
- After 5 minutes from the end of the programme.

- Turn items with the internal layer made of cotton inside out. Cotton layer must be faced outwards.
- Always set the programme suitable for the type of laundry.
- Do not put light and dark colours together.
- Use suitable programme for cottons, jersey and knitwear to reduce shrinkage.
- Do not exceed the maximum load stated in the programmes chapter or shown on the display.
- Dry only the laundry that is suitable for tumble drying. Refer to the fabric label on the items.
- Do not dry large and small items together. Small items can be trapped inside the large items and remain wet.
- Shake the large clothes, fabrics before placing in the tumble dryer. It is to avoid moist places inside the fabric after the drying cycle.

Fabric label	Description
	Laundry is suitable for tumble drying.
	Laundry is suitable for tumble drying at higher temperatures.
	Laundry is suitable for tumble drying at low temperatures only.
	Laundry is not suitable for tumble drying.

# CARE AND CLEANING

## CLEANING THE FILTER



**CAUTION!** Clogged filter leads to the emergency heater shutdown. As a consequence the laundry remains cold and wet. The display shows 1 min or few minutes to the cycle end for a longer time.  
The filter cleaning fixes above problems.



**CAUTION!** Avoid the use of water to clean the filter. Instead throw away lint in the dustbin ( avoid dispersion of plastic fiber in water ambient).



To achieve the best drying performances clean the filter regularly , clogged filter lead to longer cycles and energy consumption increase.  
Use your hand to clean the filter , and if necessary , a vacuum cleaner .

1.

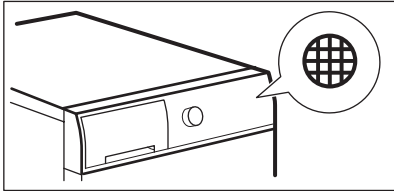

3.

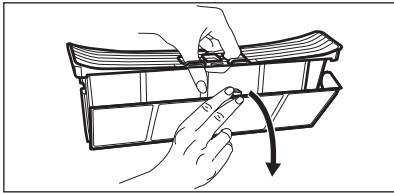

5.

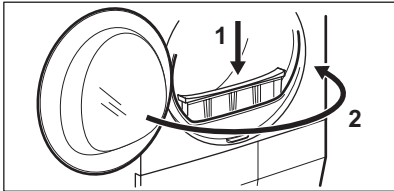

2.

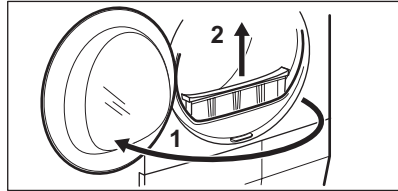

4.

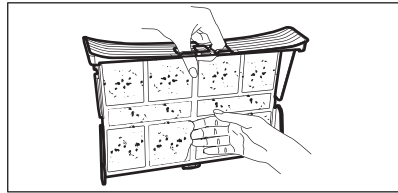

## EMPTYING THE WATER CONTAINER

1.

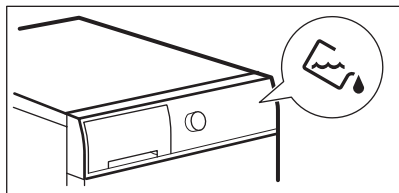

2.

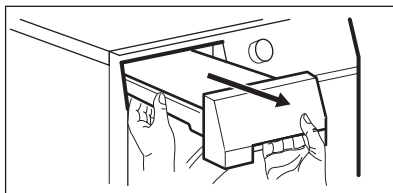

3.

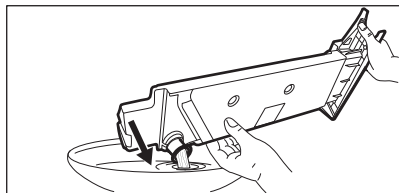

4.

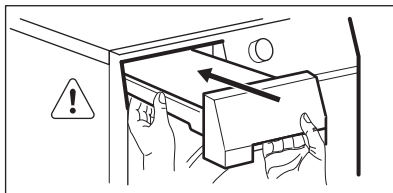

You can use the water from the water container as an alternative to distilled water (e.g. for steam ironing). Before you use the water, remove dirt residues with a filter.

## CLEANING THE CONDENSER

1.

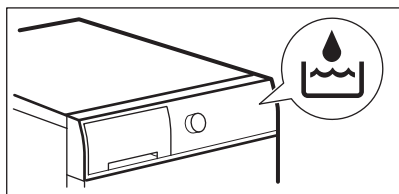

2.

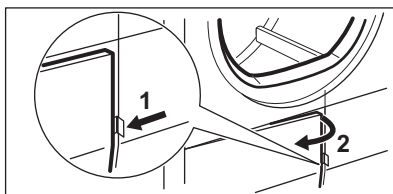

3.

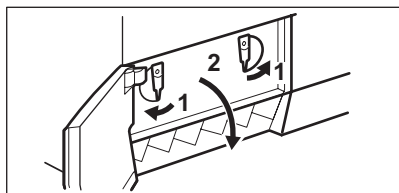

4.

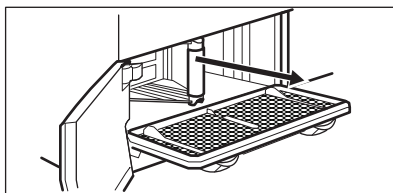

5.

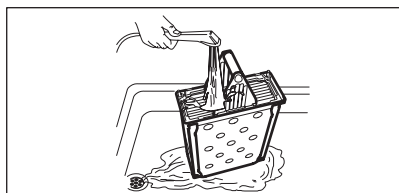

6.

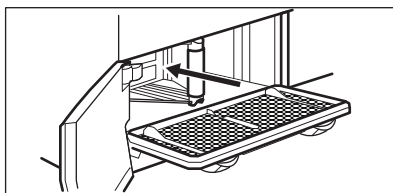

7.

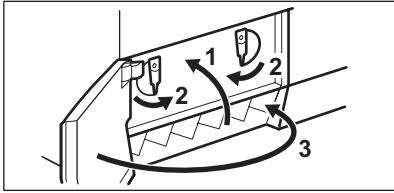

### CLEANING THE HUMIDITY SENSOR



**CAUTION!** Risk of humidity sensor damage. Do not use abrasive materials or steel wool to clean the sensor.

To assure best drying results the appliance is equipped with metal humidity sensor. It is placed on the inner side of the door area.

Over usage time the surface of the sensor may get dirty which deteriorates the drying performance.

We recommend to clean the sensor at least 3 or 4 times or if you observe the drop of drying performance.

To clean you can use harder side of dish-washing sponge and bit of vinegar or dish soap.

To clean the sensor:

1. Open the loading door.
2. Clean the surfaces of the humidity sensor wiping off the metal surface several times.

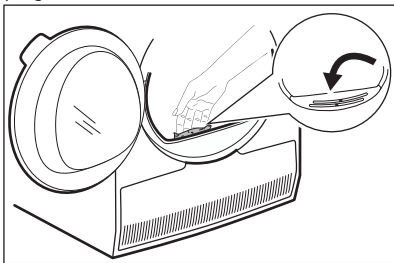

### CLEANING THE DRUM



**WARNING!** Disconnect the appliance before you clean it.

Use a standard neutral soap detergent to clean the inner surface of the drum and drum lifters. Dry the cleaned surfaces with a soft cloth.



**CAUTION!** Do not use abrasive materials or steel wool to clean the drum.

### CLEANING THE CONTROL PANEL AND HOUSING

Use a standard neutral soap detergent to clean the control panel and housing.

Use a moist cloth to clean. Dry the cleaned surfaces with a soft cloth.



**CAUTION!** Do not use furniture cleaning agents or cleaning agents which can cause corrosion.

### CLEANING THE AIRFLOW SLOTS

Use a vacuum cleaner to remove fluff from the airflow slots.

## TROUBLESHOOTING



**WARNING!** Refer to Safety chapters.

### ERROR CODES

The appliance does not start or it stops during operation.

First try to find a solution to the problem (refer to the table). If the problem persists, contact the Authorised Service Centre.



**WARNING!** Deactivate the appliance before carrying out any check.

**In case of major problems, the acoustic signals operate, the display shows an error code and the  Marche/Arrêt button may flash continuously:**

Error code	Possible cause	Remedy
<b>E5A</b>	Appliance motor overloaded. Too much laundry or entrap in the drum.	The programme was not completed. Remove the laundry from the drum, set the programme and restart the cycle.
<b>E97</b>	Internal fail. No communication between electronic elements of the appliance.	The programme was not finished properly or the appliance stopped too early. Switch the appliance off and on again. If the error code appears again, contact the Authorised Service Centre.
<b>EHO</b>	The mains supply is unstable.	When the appliance is showing <b>EHO</b> , please wait until main supply is stable than press start. If the appliance pause the cycle without any indication then press the cycle start. If the warning will occur check the power cord / socket integrity or main supply.

If the display shows other error codes, deactivate and activate the appliance. If the problem continues, contact the Authorised Service Centre.

In case of different problem with the tumble dryer check the table below for possible solutions.

## TROUBLESHOOTING

Problem	Possible solution
You cannot activate the appliance.	Make sure that the mains plug is connected to the mains socket. Check fuse in fuse box (domestic installation).
The programme does not start.	Press Marche/Arrêt. Make sure that the appliance door is closed.
The appliance door does not close.	Make sure that the installation of the filter is correct.
The appliance stops during operation.	Make sure that the laundry does not catch between the appliance door and the rubber seal. Make sure that the water container is empty. Press Marche/Arrêt to start the programme again.



Problem	Possible solution
	Load is too small, increase the load or use the Minuterie programme.
The cycle time is too long or unsatisfactory drying result. <sup>1)</sup>	Make sure that the weight of the laundry is applicable to the duration of the programme.
	Make sure that the filter is clean.
	The laundry is too wet. Spin the laundry in the washing machine again.
	Ensure that the room temperature is higher than +5°C and lower than +35°C. Optimal room temperature is 18°C to 25°C.
	Set the Minuterie or the Très sec programme. <sup>2)</sup>
The tumble dryer does not heat up. The laundry inside is cold and wet. The filter is clogged. The emergency heater shut-down.	Clean the filter (see chapter <i>CARE AND CLEANING</i> ).
Display shows 1 min or few minutes to the cycle end for longer time. The laundry inside is cold and wet. The filter is clogged. The emergency heater shut-down.	Clean the filter (see chapter <i>CARE AND CLEANING</i> ).
The display shows <b>Err</b> .	If you want to set a new programme, deactivate and activate the appliance.
	Make sure that the options are applicable to the programme.
The display shows an Error code (e.g. <b>E51</b> ).	Deactivate and activate the appliance. Start a new programme. If the problem occurs again, contact the Service.

1) After maximum 6 hours, the programme ends automatically.

2) It can happen that some area remains humid when drying big items (e.g. bed sheets).

#### If the drying results are not satisfactory

- The set programme was incorrect.
- The filter is clogged.
- The condenser is clogged.
- There was too much laundry in the appliance.
- The drum is dirty.
- Incorrect setting of the conductivity sensor ( See chapter "*Settings - Adjustment of the*

*remaining laundry moisture degree "* for better setting).

- The airflow slots are clogged.
- Room temperature is too low or too high ( optimal room temperature 18°C to 25°C )

## TECHNICAL DATA

Height x Width x Depth	850 x 596 x 555 mm (maximal 583 mm)
------------------------	-------------------------------------

Max. depth with the appliance door open	1019 mm
Max. width with the appliance door open	945 mm
Adjustable height	850 mm (+ 15 mm - feet regulation)
Drum volume	104 l
Maximum load volume	<b>7</b> kg
Voltage	230 V
Frequency	50 Hz
Sound power level	67 dB
Total power	2800 W
Energy efficiency class	<b>B</b>
Energy consumption on the standard cotton programme with the full load. <sup>1)</sup>	<b>4,23</b> kWh
Energy consumption on the standard cotton programme with the partial load. <sup>2)</sup>	<b>2,29</b> kWh
Annual energy consumption <sup>3)</sup>	503,50 kWh
Left-on mode power absorption <sup>4)</sup>	0,50 W
Off mode power absorption <sup>4)</sup>	0,50 W
Type of use	Household
Allowed ambient temperature	+ 5°C to + 35°C
Level of protection against ingress of solid particles and moisture ensured by the protective cover, except where the low voltage equipment has no protection against moisture	<b>IPX4</b>

**1)** With reference to EN 61121. 7 kg of cotton centrifuged at 1000 rpm.

**2)** With reference to EN 61121. 3,5 kg of cotton centrifuged at 1000 rpm.

**3)** Energy consumption per year in kWh, based on 160 drying cycles of the standard cotton programme at full and partial load, and the consumption of the low-power modes. Actual energy consumption per cycle will depend on how the appliance is used (REGULATION (EU) No. 392/2012).

**4)** With reference to EN 61121.

The information given in the chart above is compliant with the EU Commission regulation 392/2012 implementing directive 2009/125/EC.

## CONSUMPTION DATA



Stated values are obtained in laboratory conditions with relevant standards. Different parameters can change the data, for example: the quantity of laundry, the type of laundry and the ambient conditions. The initial moisture content of the laundry, the water type and the supply voltage may also affect the energy use and the duration of the drying programme.

Programme	Spun at / residual humidity	Drying time <sup>1)</sup>	Energy consumption <sup>2)</sup>
<b>Coton Eco 7 kg</b>			
Prêt à ranger	1400 rpm / 50%	111 min.	3,63 kWh
	1000 rpm / 60%	129 min.	4,23 kWh
<b>Coton 7 kg</b>			
Prêt à repasser	1400 rpm / 50%	79 min.	2,71 kWh
	1000 rpm / 60%	98 min.	3,36 kWh
<b>Coton Eco 3,5 kg</b>			
Prêt à ranger	1400 rpm / 50%	62 min.	1,96 kWh
	1000 rpm / 60%	72 min.	2,29 kWh
<b>Synthétiques 3,5 kg</b>			
Prêt à ranger	1200 rpm / 40%	55 min.	1,56 kWh
	800 rpm / 50%	67 min.	1,90 kWh

1) For partial loads, the cycle time is shorter and appliance uses less energy.

2) Improper ambient temperature and/or poorly centrifuged laundry can prolong cycle time and increase the energy consumption.

## PRODUCT INFORMATION SHEET IN REFERENCE TO E.U. REGULATION 1369/2017

Product Information Sheet	
Trade Mark	FAURE
Model	FDP7406PZ PNC916099050
Rated capacity in kg	7
Air vented or condenser tumble dryer	Condenser
Energy efficiency class	B
Energy consumption in kWh per year, based on 160 drying cycles of the standard cotton programme at full and partial load, and the consumption of the low-power modes. Actual energy consumption per cycle will depend on how the appliance is used.	503,50
Automatic tumble drier or non-automatic tumble drier	Automatic
Energy consumption of the standard cotton programme at full load in kWh	4,23
Energy consumption of the standard cotton programme at partial load in kWh	2,29

Power consumption of the off-mode in W	0,50
Power consumption in left-on mode in W	0,50
Duration of the left on mode in minutes	10
The 'standard cotton programme' used at full and partial load is the standard drying programme to which the information in the label and the fiche relates, this programme is suitable for drying normal wet cotton laundry and it is the most efficient programme in terms of energy consumption for cotton.	
Weighted programme time of the 'standard cotton programme at full and partial load' in minutes	96
Programme time of the 'standard cotton programme at full load' in minutes	129
Programme time of the 'standard cotton programme at partial load' in minutes	72
Condensation efficiency class on a scale from G (least efficient) to A (most efficient)	B
Average condensation efficiency of the standard cotton programme at full load as a percentage	81
Average condensation efficiency of the standard cotton programme at partial load as a percentage	81
Weighted condensation efficiency for the 'standard cotton programme at full and partial load'	81
Sound power level in dB	67
Built in appliance Y/N	No

The information given in the chart above is compliant with the EU Commission regulation 392/2012 implementing directive 2009/125/EC.

## ENVIRONMENTAL CONCERNS

Recycle materials with the symbol . Put the packaging in relevant containers to recycle it. Help protect the environment and human health by recycling waste of electrical and electronic appliances. Do not dispose of appliances marked

with the symbol  with the household waste. Return the product to your local recycling facility or contact your municipal office.







136982771-A-182022



CE

**FAURE**